

# Telephone HT60D

User Manual

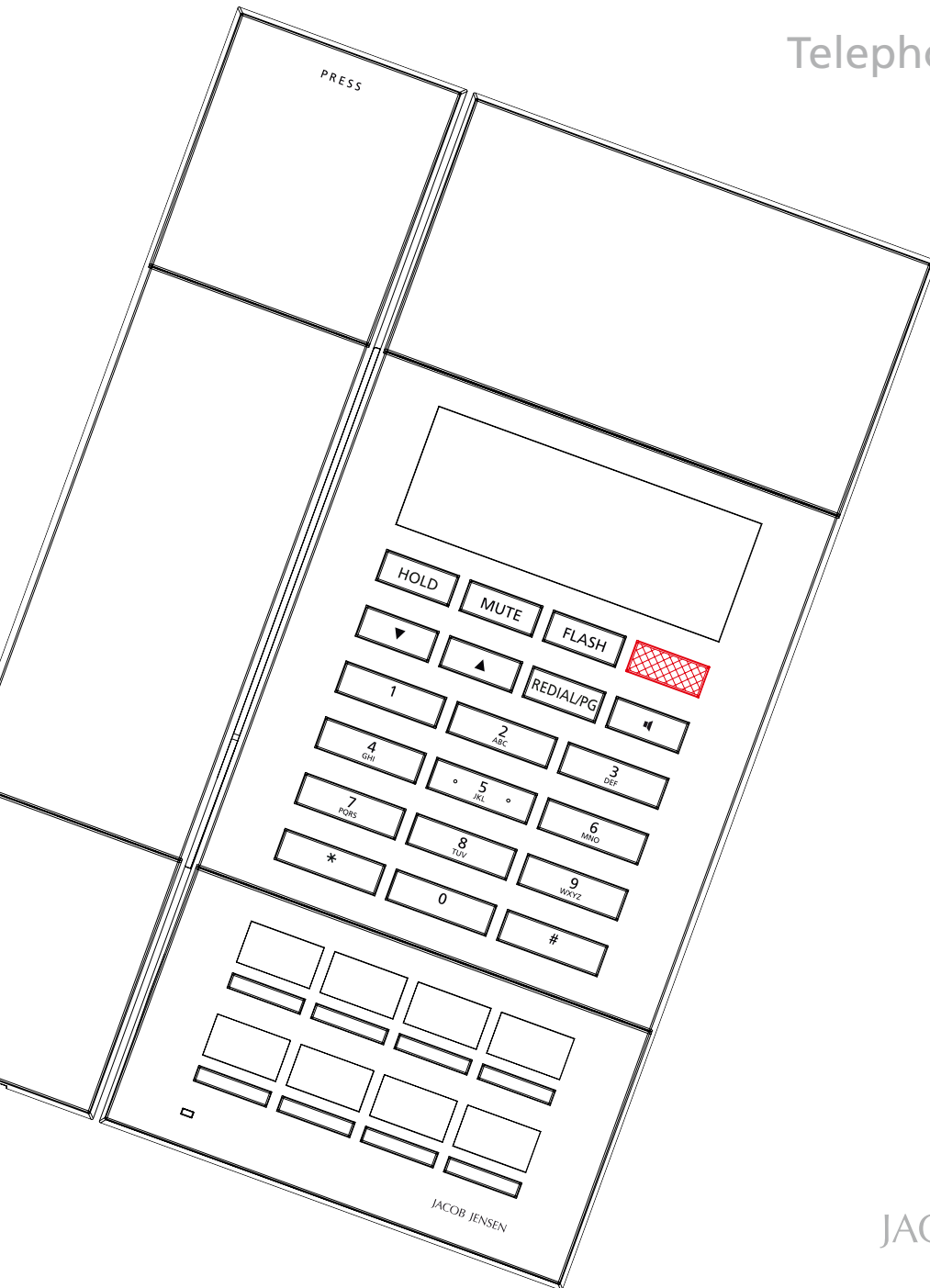

JACOB JENSEN™

# CONTENTS

The following items are included in the package of JACOB JENSEN Telephone HT60D:

- 1. Telephone handset
- 2. Base station
- 3. Handset coiled cord
- 4. Table stand
- 5. Line cord
- 6. HS20D

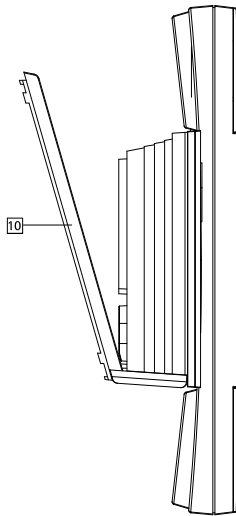
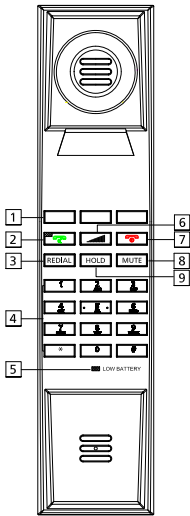
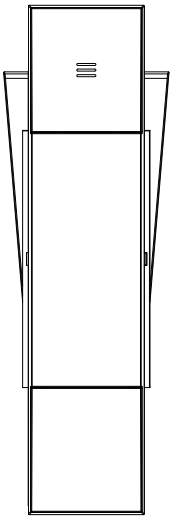
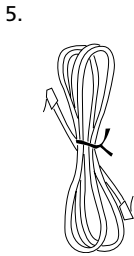
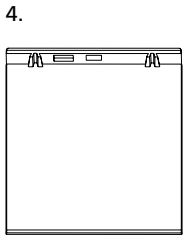
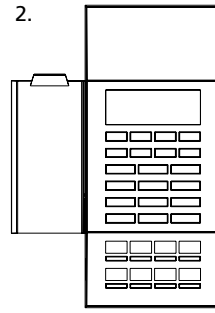
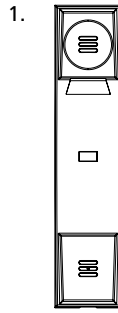

## MAIN FEATURE LIST

1. The Handset can make/answer any calls freely. One Base can work with 1- 4 Handsets.
2. Supports 1.8/1.9GHz, DECT6.0 standards. Also supports WDCT standard. Adopts HF numerical coding technique between Base and Handsets.
3. Handsets can charge rapidly and give low power warning.
4. Eight service keys can be customized to client's requirements.
5. The volume is adjustable over five levels.
6. Redial button, the last dialed number will disappear in 5 minutes.
7. Hold and Mute
8. Message Waiting Indicator

## CONTROLS AND FUNCTIONAL KEYS

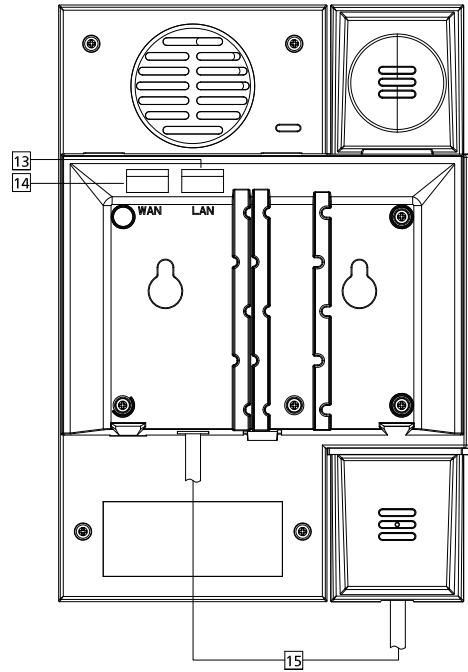
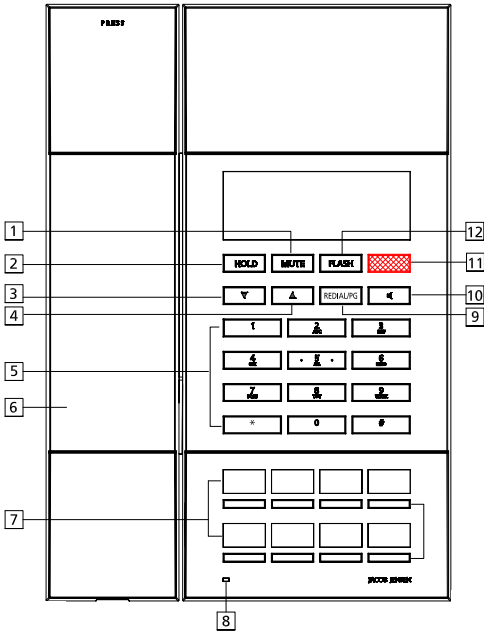

- 1. MUTE Key
- 2. HOLD Key
- 3. VOL -
- 4. VOL +

- 5. Number Keys
- 6. Handset
- 7. Service keys
- 8. Indicator

- 9. Redial / PAGE
- 10. Speaker
- 11. MWL
- 12. FLASH

- 13. To Tel Port
- 14. Data Port
- 15. Handset Cord

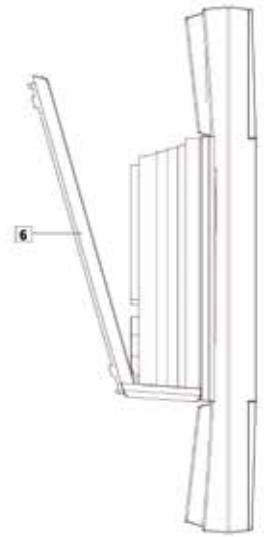
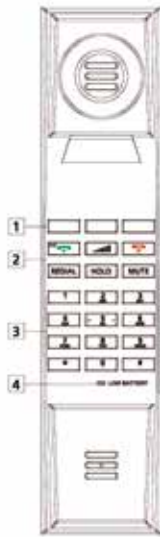

- 1. Service keys
- 2. Function Keys
- 3. Number keys
- 4. Low Power Indicator
- 5. Bracket
- 6. Charging Indicator

## CONGRATULATIONS ON YOUR NEW JACOB JENSEN™ TELEPHONE

HT60D including JACOB JENSEN™ HS20D cordless Handset: The telephone is designed in Denmark by Jacob Jensen, whose products have gained international recognition for their original, simple and classic design. Jacob Jensen™ has received about 100 prizes from around the world and has 19 products included in The Design Study Collection and The Design Collection of The Museum of Modern Art in New York.

The HT60D has been designed specifically for hotel use. Voice over DECT technologies is employed for clear sound and reliable operation.

### Installation

1. Installation of the power adapter and telephone cord on the HT60D Base.

First please connect the T-Cable's power jack (Marked 1 in the figure below) with the power adaptor. Then please connect the T-Cable's RJ11 (4 pin. Marked 2 in the below figure) with the telephone line socket in the room. Finally please connect the T-Cable's RJ11 port (6 pin. Marked 3 in the below figure) to telephone set's "TO TEL" port, which is on the back of the phone.

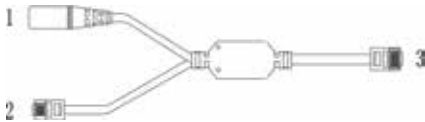

2. Installation and disassembly of the bracket on the HT60D Base

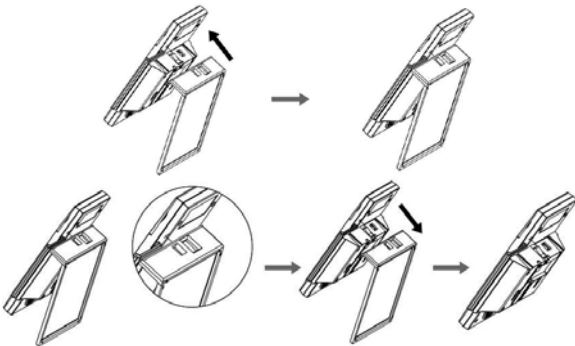

3. Installation of power adapter on the HS20D

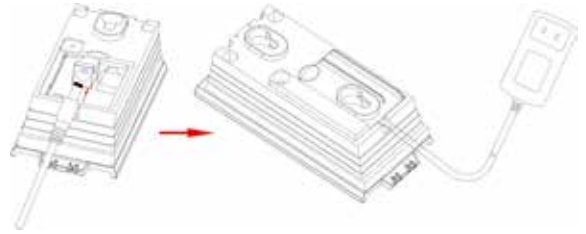

4. Installation and removal of the bracket on the HS20D6.

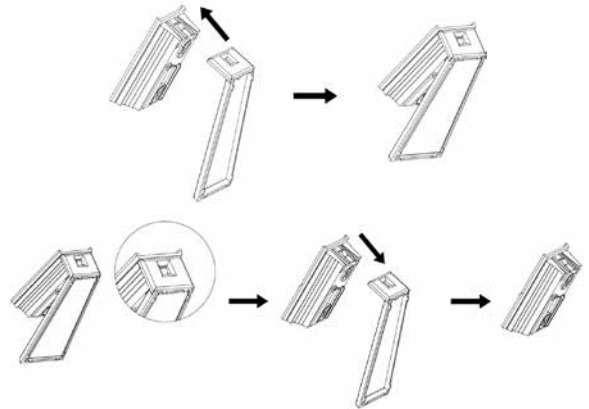



### Notes

1. Please install the phone in dry and clean environment and avoid contact with damp.
2. Install away from fire, water spray and shock. Clean with a soft damp cloth. Do not use chemical solvent.
3. Install the supplied chargeable battery in the handset. Note the polarity of the connector.



## OPERATION

### Making a call

1. When the cordless handset is in the charging station, picking up the handset will enter off-hook status.
2. When the cordless handset isn't in the charging station, pressing the  (green button) will enter off-hook status. Pressing the  (green button) again will enter Speaker status.
3. On-hook status, press  on the base to enter Speaker mode. The IN USE indicator will flash
4. On-hook status, pick up of handset of the base can make a call and the IN USE indicator will flash

**Note: Without external power, only the corded handset can work.**

### Answering a Call

1. When the cordless handset is in charging station, picking up the handset will answer the call
2. When the cordless handset isn't in the charging station, pressing the  (green button) will enter speaker status and pressing the  (green button) again will enter non-speaker status.
3. When there is a call, press  on the base to enter Speaker mode
4. When there is a call, pick up the base handset to answer the call.



### Volume Adjustment

1. For cordless handset



Off-hook, please press  to adjust the voice volume;

On-hook, please press  to adjust the ringer volume.

2. For the base

Off-hook, press  or  to adjust the voice volume. There are five levels.

## HOLD

1. Press HOLD key, the indicator will turn on, the current line is held
2. Press HOLD key again or press  of the handset or press  on the base to release the hold mode.

### REDIAL

Off-hook, press REDIAL key of the base or the handset to dial the last number dialed.

**Note: The last dialed number will disappear automatically after five minutes.**

### PAGE

On-hook status, press REDIAL / PG will call the cordless handset.

### Mute

Off-hook mode, press MUTE key once to mute the microphone, press it again to remove the mute mode (LED indicator on Base).

### Registration

- 1) On-hook status, press HOLD + \* + HOLD + MUTE on the base ( the indicator of SPKR, MUTE and HOLD will flash),
- 2) Press HOLD + \* + HOLD + MUTE of the cordless handset,
- 3) After 5-8s, press REDIAL / PG key on the base.
- 4) The handset will ring, which means successful registration.

### Service Keys







1. Off-hook mode, press a service key to dial the number directly.
2. How to Store:  
Keep the base in on-hook mode, press HOLD+ Desired number + Service key / MWL key. There will be indicating tone if successful.

For the cordless handset, in on-hook status, press HOLD + Desired number + HOLD + Service key

3. How to delete:

On-hook mode, press HOLD+HOLD+ service key / MWL key of the base. Please make sure that there is power.

### Handset / Base speaker mode and Handset / Base intercom

1. Press  on the cordless handset to enter speaker mode; press  again will enter non-speaker mode
2. For the base, picking up the corded handset will enter into non-speaker mode; press  and put the corded handset back on the base to enter into speaker mode.
3. From Base to cordless Handset:  
When Base is in speaker mode or handset mode, press  on the handset and press  on the base, it will enter handset non-speaker mode.
4. From cordless Handset to Base:  
When Handset is calling, press  on the base or pick up the corded handset, then press  key on the handset.

### MAINTENANCE

The phone has been manufactured using the very latest technology and the highest quality components and workmanship, under ISO9001 quality control procedures.

It can be relied on to provide many years of trouble-free service, especially if these simple tips are followed:

- Handle with care, avoiding hard knocks and shocks.
- Do not expose this product to dust, strong sunlight, humidity, high temperature, or mechanical shock.
- Do not use corrosive or abrasive cleansers on this product. Keep the unit dust free by wiping it with a soft, damp cloth.
- Do not tamper with or attempt to modify the phone, it would make it unsafe to use. Should any service difficulties or faults be encountered, the following list may help you identify and remedy problems. In some cases, however, it may be necessary to call the distributor from whom you purchased it.



## TROUBLESHOOTING

1. No dialing tone on handset
  - 1) Please check the telephone network,
  - 2) Please check the connection of handset cord and straight line cord
2. No ringing or continuous ring.  
Please check the telephone line or the number of phones connected in parallel.
3. Noise during call.  
Please check the telephone line or please check the handset cord
4. Cordless handset can not be switched on.
  - 1) If there is an error sound after pressing  (green button), it means that cordless handset wasn't registered to the phone base, you may need to register it again.
  - 2) Cordless handset and phone base's distance beyond range, need to move cordless handset closer to base.
  - 3) Batteries do not have enough power, need to recharge
5. If there is any problem, please don't open the phone body, please contact us or our local representative.  
Thanks.

## BATTERY

1. The battery should be charged for over 8 hours for the first time or if the battery hasn't been used for some time.
2. After 3 or 4 charges, the new battery will reach full capacity.
3. If the phone will not be used for a long time, please remove the battery and keep it in a dry place.
4. The battery should be changed after 20 months using a genuine battery from a Bittel supplier.

## FCC APPROVAL

Complies with Part 68 of the FCC rules. On the bottom of this telephone is a label that contains, among other information, the FCC registration number and the ringer equivalence number (REN) for this telephone. If requested, you must provide this information to the Telephone Company.

## EC Declaration of Conformity

Hereby Bittel declares that this equipment is in compliance with the essential requirements and other relevant provisions of Directive 2014 / 53 / EU.

Jacks:

Use RJ11C USOC standard modular jacks.

## WARRANTY

This product is warranted for a period of 12 months from the date of purchase against faulty materials or workmanship.

If during this period a defect arises, we may repair or replace the product, at Bittel's discretion, provided that:

1. The product has not been used for any purpose other than normal use.
2. Unauthorized product repair or modifications have not been attempted.
3. The product has never been used in a harsh or corrosive environment.
4. No damage in transit.

THIS LIMITED WARRANTY GIVES THE BUYER SPECIFIC LEGAL RIGHTS. THE BUYER MAY ALSO HAVE OTHER RIGHTS WHICH VARY FROM JURISDICTION TO JURISDICTION.

This warranty is only valid for merchandise purchased directly from Bittel or dealers or distributors authorized by Bittel Co.

## FCC WARNING

This device complies with part 15 of the FCC Rules. Operation is subject to the following two conditions: (1) This device may not cause harmful interference, and (2) this device must accept any interference received, including interference that may cause undesired operation.

## CONTACT INFORMATION

### Shandong Bittel Intelligent Technology Co., Ltd.

Telephone: (86) 633-2212119 / 2212113  
Internet: [www.bittelgroup.com](http://www.bittelgroup.com), [www.hotellphone.com](http://www.hotellphone.com)  
Email: [info@bittelgroup.com](mailto:info@bittelgroup.com)  
Address: Shandong Bittel Intelligent Technology Co., Ltd. No. 1 Rizhao North Road, Rizhao, Shandong, 276800, China

### Service center North America:

#### Guestroom Technologies Inc.

1722 Little Orchard Street San Jose, California 95125 USA  
Telephone: 1-888-9-BITTEL or 1-408-298-8206

Copyright © 2015 Bittel Inc. All rights reserved.

Produced under licence from:

### Bell Xpress A/S

Telephone: (45) 70 22 60 33  
Internet: [www.bellxpress.dk](http://www.bellxpress.dk)  
Email: [mail@bellxpress.dk](mailto:mail@bellxpress.dk)  
Address: Sletvej 50, DK-8310 Tranbjerg J, Denmark

## ENVIRONMENTAL CONCERNS AND DISPOSAL

Electric and electronic appliances contain materials, components and substances that can be damaging to people's health and to the environment, if the waste is not disposed of correctly. Electric and electronic appliances are marked with a crossed-out wheellie bin symbol as illustrated below. It indicates that electric and electronic appliances are banned from being disposed of as general household waste, and have to be collected separately.

Please ask you dealer about current means of disposal.



- The contents of this manual are subject to change without notice.
- The manufacturer and its suppliers accept no liability whatsoever for any damage, expense, loss of profits or any other damage incurred as a result of using this product.

Product by: Bell Xpress A/S, Sletvej 50, 8310 Tranbjerg J, Denmark · [www.bellxpress.dk](http://www.bellxpress.dk)

[www.jacobjensen.com](http://www.jacobjensen.com)



Generation to generation...