

Telephone IP60D

User Manual

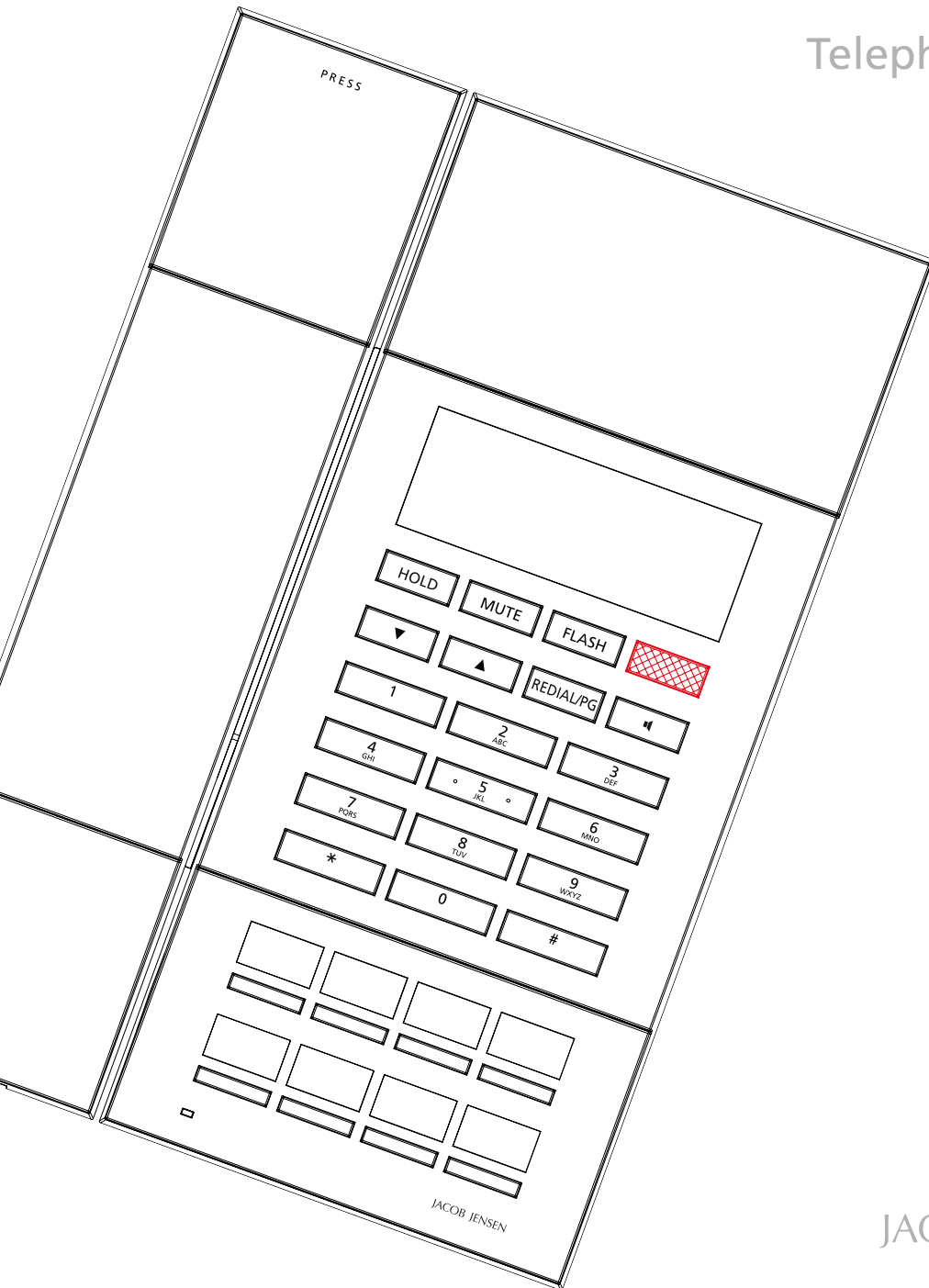

JACOB JENSEN™

CONTENTS

The following items are included in the package of JACOB JENSEN Telephone IP60D:

1. Telephone handset
2. Base station
3. Handset coiled cord
4. Table stand
5. Line cord
6. HS20D

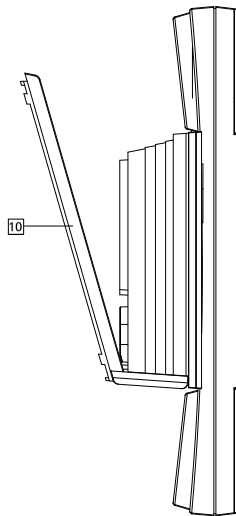
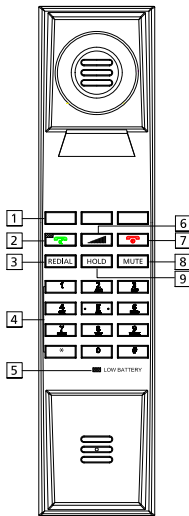
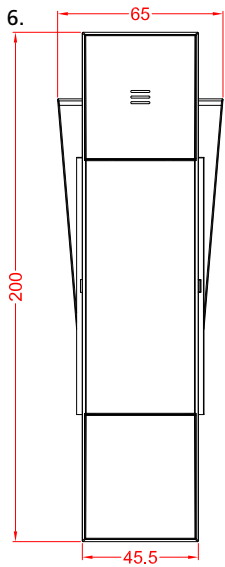
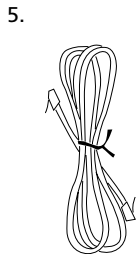
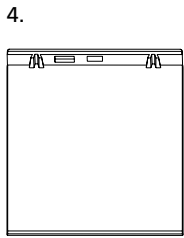
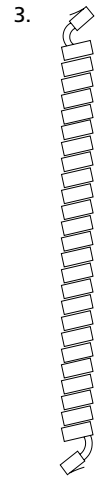
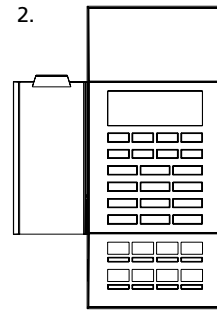
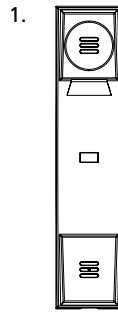

MAIN FEATURE LIST

1. The Base and Handset can make/answer calls independently. One Base can work with 1–4 Handsets.
2. Supports SIP V2/SDP/RTP/RTCP/STUN/SNTP/ DNS/SNMPv2 protocols.
3. Supports IEEE802.1 Q standard, IEEE802.3af protocols.
4. Supports G.711/G.722(HD Voice)/G.723/G.729AB /G.726/ iLBC
5. Supports 1.8/1.9Ghz, DECT6.0 and adopts HF numerical coding technique between Base and Handsets.
6. Mute, hold, flash, redial and Speaker feature
7. Message waiting light compatible with main PBX, MWL indicator and withdraw feature
8. Owns ten (10) service keys
9. Both Base volume and Handset volume are adjustable (5-levels)
10. Supports DHCP and static IP address protocol for getting IP address.
11. Supports upgrade through HTTP/TFTP protocol.
12. Adopts dynamic speech detection; Comfortable noise generation; Speech buffering technologies.
13. Integrated PoE power supply and external POE adapter power supply.
14. The handset on the base is corded.

CONTROLS AND FUNCTIONAL KEYS

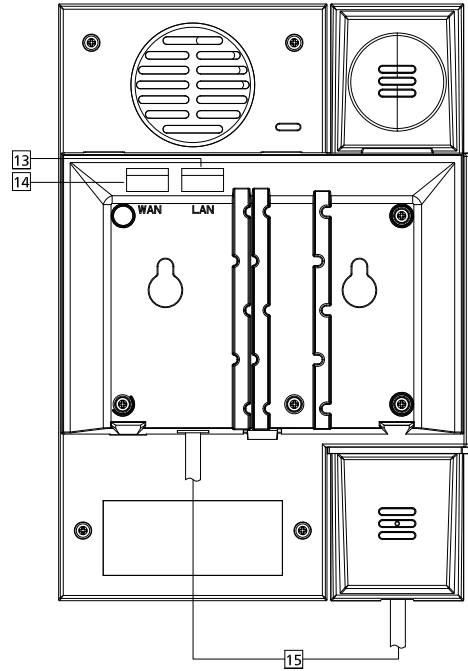
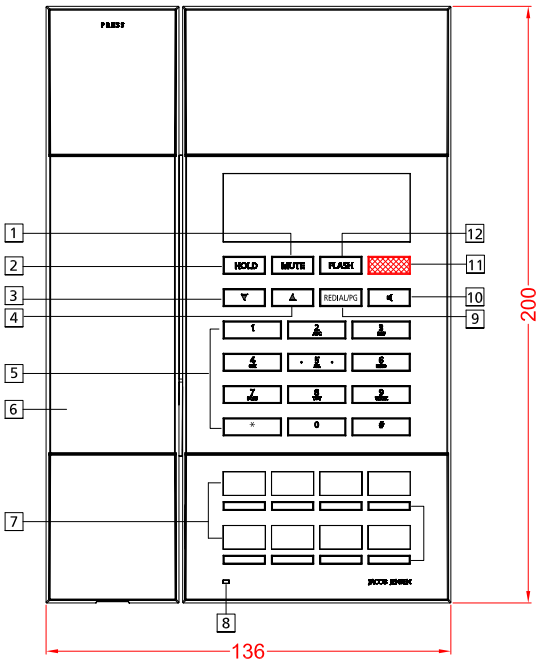





- 1. MUTE Key
- 2. HOLD Key
- 3. VOL -
- 4. VOL +

- 5. Number Keys
- 6. Handset
- 7. Service keys
- 8. Indicator

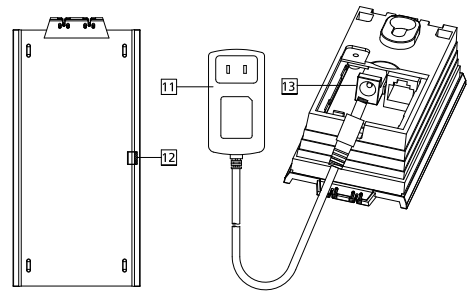
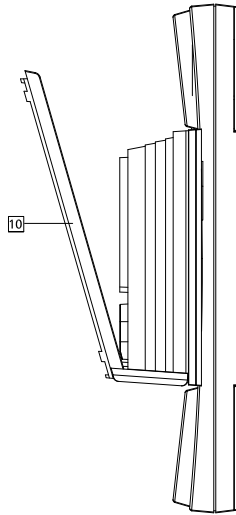
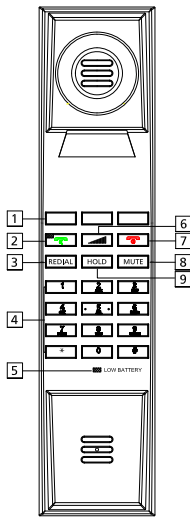
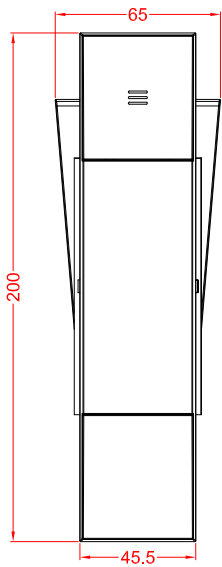
- 9. Redial/PG
- 10. Speaker
- 11. MWL
- 12. FLASH

- 13. DC Jack
- 14. LAN Port
- 15. WAN Port
- 16. Handset Jack



- | | |
|---|----------------------|
| 1. Service keys | 8. MUTE |
| 2.  | 9. HOLD |
| 3. REDIAL | 10. Bracket |
| 4. Number key | 11. Power Adaptor |
| 5. Low Power Indicator | 12. Charge Indicator |
| 6.  | 13. DC Jack |
| 7.  | |

CONGRATULATIONS ON YOUR NEW JACOB JENSEN™ TELEPHONE

IP60D including JACOB JENSEN™ HS20D cordless Handset: The telephone is designed in Denmark by Jacob Jensen, whose products have gained international recognition for their original, simple and classic design. Jacob Jensen™ has received about 100 prizes from around the world and has 19 products included in The Design Study Collection and The Design Collection of The Museum of Modern Art in New York.

The IP60D has been designed specifically for hotel use. Voice over IP and DECT technologies are employed for clear sound and reliable operation. SIP protocols ensure compatibility with all major brands.

Installation

1. Please place the supplied chargeable battery into the handset, making sure the polarity of the jack and socket match. Always use the same specification battery as that supplied with phone..
2. Please connect the phone handset cord
3. Power by POE: Connect the output end to the WAN port of the phone and connect the input end to the Internet cable from hotel switch POE port.
4. Power by adaptor (The default is POE)
Please connect the 9V power adapter to the DC power input, which is in the rear of the phone; connect the Internet cable to WAN port of the phone, and connect the Internet cable to the LAN port of Data port/access point.
5. Please install the phone in a dry and clean environment and avoid contact with damp.
6. The telephone should not come in to contact with fire, water spray, or shock. Clean the surface with a soft damp cloth; never use chemical solvents.

CONFIGURE THE PHONE THROUGH WEB INTERFACE

1. IP address broadcast

In off-hook mode, press * button four times to enter the voice menu. Press 1 (network setting) then press 2 (WAN port IP address), a voice synthesizer will announce the IP address.

2. WEB interface

Input the obtained IP address to launch WEB interface `http://xxx.xxx.xxx.xxx`. Type in user and password to log in WEB interface.



3. Launch WEB interface

Input the obtained IP address to launch WEB interface `http://xxx.xxx.xxx.xxx`. Type in user and password to log in WEB interface.



Note:

- 1) Both the user name and password in initial management mode are 'admin'.
 - 2) The default network mode is DHCP. Once the phone is connected into the network environment with DHCP service, it can get online automatically
4. WEB interface function description

4.1. Phone status

Product Information	It shows the basic information of the product.
Line Status	It shows the registration state of each line.

Network Status	It shows the information of Internet Port WIFI and PC port.
Wireless Info	It shows the current WIFI setting and status.
System Status	It shows the current time and the running time of the product.

4.2. Network status

Telephone can obtain IP address from DHCP server in default mode. Enter WEB interface to configure all related settings in accordance with real network environment.

WAN IP Mode	Select WAN port IP address obtainment modes including static/ DHCP/ PPPoE/ Bridge.
MAC Address Clone	Enable MAC address clone or not
NAT Enable	Activate NAT function or not.
VLAN Mode	Activate VLAN mode or not
VLAN ID	Set VLAN ID
DNS Mode	If DNS mode is Manual, user needs to set primary DNS and secondary DNS manually. If DNS mode is Auto, IP phone will obtain primary DNS and secondary DNS from DHCP server automatically.
Primary DNS	The Primary DNS setting
Secondary DNS	The optional DNS setting
IP Address	The network port IP address
Subnet Mask	The network port subnet mask
Default Gateway	The network port default gateway

Note:

- 1) When telephone IP address is switched from DHCP to static mode, all parameters such as IP address, Subnet Mask, Default Gateway and DNS need to be set manually.
- 2) Save and apply switched IP address settings and reboot the phone for new IP address obtainment. Make sure the network is normal during daily use.

4.3. SIP Account Setting

For normal phone usage, only the Proxy Server, Display Name , Phone Number, Account, and Password needs to be configured.

Basic	Set basic information from VoIP service supplier like phone number, account, password, SIP proxy, etc.
Audio Configuration	Select audio format
Supplementary Service Subscription	Auxiliary function
Call Waiting	Enable call waiting or not
Hot Line	Set hot line
MWI Enable	Enable MWI or not
Voice Mailbox Numbers	Voice Mailbox server
MWI Subscribe Enable	Support MWI subscription

4.4. Administration

Client can set password, languages, restore factory defaults,etc

4.5. Upgrade



Local Upgrade	Click "Browse" to select certain firmware, click Upgrade button for upgrading. After upgrade, phone will return to initial interface.
---------------	---

Note: After upgrading, please restore factory settings.

4.6. WEB Operation

Except regular configuration, please do not modify other corresponding information.

5. Voice Menu Instruction

The phone has a voice menu function; relevant information can be configured through the voice menu. After starting the phone, press the * key 4 times to enter the voice menu. Hang up to exit the voice menu.

Main Menu:

Network Configuration	After choosing key 1, the phone will enter Submenu 1.1 network configuration setting.
Telephone port configuration	After choosing key 2, the phone will enter Submenu 2.1 phone port configuration setting.
Factory Reset	After choosing key 3, enter the password; the phone will then return to factory setting.
Speed Dial configuration	After choosing key 4, enter speed-dial configuration option; enter speed-dial key, then enter the speed-dial number to complete the configuration.
Reboot	After choosing key 5, enter password; the phone will then reboot.
WAN Port Login	After choosing key 6, enter password to set up whether WAN port can allow logging.
WEB Access Port	After choosing key 7, enter password to set up Web access port.
Software Version	After choosing key 8, current software version will be broadcast.

Submenu 1.1.

Wan port connection type	After choosing key 1, the phone will broadcast current Wan port connection type; after entering password, DHCP or static IP address can be set up.
Wan port IP address	After choosing key 2, the phone will broadcast current IP address; after the broadcast is finished, IP address can be set up.
Wan port subnet mask	After choosing key 3, the phone will broadcast current subnet mask; after the broadcast is finished, subnet mask can be set up.
Gateway	After choosing key 4, the phone will broadcast current gateway; after the broadcast is finished, gateway can be set up.
DNS	After choosing key 5, the phone will broadcast current DNS; after the broadcast is finished, DNS can be set up.

Submenu 2.1.

Telephone number	After choosing key 1, the phone will broadcast current phone number.
Server IP address	After choosing key 2, the phone will broadcast current server IP address.
Physical port	After choosing key 3, the phone will broadcast current physical port.
Call transfer configuration	After choosing key 4, call transfer option can be set up.
Volume control mode	After choosing key 5, volume control mode can be selected.
Redial timing	After choosing key 6, whether redialing number will be removed after a fixed time can be set up.
Ringing voice adjusting mode	After choosing key 7, whether ringing volume adjustment is allowed can be set up.
Speed-dial button and voice mail configuration	After choosing key 8, speed-dial button can be configured.

Note:



- 1) When using voice menu configuration to achieve relevant operation, please reboot the phone.
- 2) After entering password, IP address or other number, please enter # to confirm.
- 3) When using keyboard to enter password,
Press number key 2 if A, B, C, a, b, c is to be entered.
Press number key 3 if D, E, F, d, e, f is to be entered.
Press number key 4 if G, H, I, g, h, i is to be entered.
Press number key 5 if J, K, L, j, k, l is to be entered.
Press number key 6 if M, N, O, m, n, o is to be entered.
Press number key 7 if P, Q, R, S, p, q, r, s is to be entered.
Press number key 8 if T, U, V, t, u, v is to be entered.
Press number key 9 if W, X, Y, Z, w, x, y, z is to be entered.
When using the keyboard to enter the password, other characters can be replaced by number key 0.
When entering IP address, use "" to replace "."; for example, if the IP address is 192.168.10.100 enter 192*168*10*100 instead.
- 4) Press * key one time to return to the menu; press * key twice to return to the menu if in IP address entering status.
- 5) Hang up the phone to exit the voice menu.

BASIC OPERATION OF PHONE



1. To register the Handset

- 1) On-hook status, press HOLD+*+HOLD+MUTE on the base (the indicator of SPKR, MUTE and HOLD will flash),
- 2) Press HOLD+*+HOLD+MUTE on the cordless handset,
- 3) After 5-8s, press REDIAL/PG key on the base.
- 4) The handset will ring, which means successful registration.

2. Off-hook

Press  on the handset or press  button on the base.

3. On-hook

- 1) Put the handset back on the base or press  again
- 2) Please press  key of the handset or put the Handset back on the charging base
- 3) Press  button again if it's in speaker mode.

4. Service Button

- 1) Off-hook mode, press a service key to dial the number directly.
- 2) How to Store:
Keep the base in on-hook mode, press HOLD+ Desired number + Service key / MWL key. There will be indicating tone if succeed.

For the handset, in on-hook mode, press HOLD + *+HOLD+N+M of the base (N=1,2 or 3, which stands for the location of the service button of the handset; M stands for the service button of base) .



For example, if you want to program the 2nd service button of the handset and the desired number is same as the 7th service button of the base, the solution is:

On-hook status, press HOLD + *+HOLD+2+7th service button on the base.

3) How to delete:

On-hook mode, press HOLD+HOLD+ service key / MWL key of the base. Please make sure that there is power.

5. Using the hold key

Press HOLD key, the indicator will turn on, the current line is held, press HOLD key again or press  of the handset or press  on the base can release the hold mode.

6. Mute

Off-hook mode, press MUTE key once to mute the microphone, press it again to remove the mute mode (LED indicator on Base).

7. Adjust the call volume

- 1) Press ▲ or ▼ on the base to adjust the volume. There are five levels.
- 2) Press  to adjust the volume. There are five levels.







8. To redial the last number dialed and Call the handset

- 1) Off-hook, press REDIAL key of the base or the handset to dial the last number dialed.
- 2) Default mode:
After on-hook, the last dialed number will disappear automatically within five minutes.

9. MWL Message Waiting Light

When there is new message, the MWL will flash, press the MWL key to retrieve the message

10. Handset/Base speaker mode and Handset/Base intercom

- 1) Press  on the cordless handset to enter speaker mode; press  again will enter non-speaker mode
- 2) For the base, picking up the corded handset will enter into non-speaker mode; press  and put the corded handset back on the base to enter into speaker mode.
- 3) From Base to Handset:
When Base is in speaker mode or handset mode, press  on the handset and press  on the base, it will enter handset non-speaker mode.
- 4) From Handset to Base:
When Handset is calling, press  on the base or pick up the corded handset, then press  key on the handset.

RESTORE FACTORY

When the phone is powered on, after it boots up successfully, press 3 when in the voice menu, enter the phone password + # Key to restore factory settings, then reboot the phone.

POE POWER SUPPLY INSTRUCTIONS

The phone can view the POE power supply level by managing the POE switch. If powering the sound or charging stand, the power level is 0 or 6 and the maximum value is 12.95W; If only powering a phone, the power level is 2 and the maximum value is 6.49W. The power level of this type is 2.

INSTALLATION ATTENTION & MAINTENANCE

The phone has been manufactured using the very latest technology and the highest quality components and workmanship, under ISO9001 quality control procedures. It can be relied on to provide many years of trouble-free service, especially if these simple tips are followed:

- Handle with care, avoiding hard knocks and shocks.
- Do not expose this product to dust, strong sunlight, humidity, high temperature, or mechanical shock.
- Do not use corrosive or abrasive cleansers on this product. Keep the unit dust free by wiping it with a soft, damp cloth.
- Do not tamper with or attempt to modify the phone, it would make it unsafe to use. Should any service difficulties or faults be encountered, the following list may help you identify and remedy problems. In many cases, however, it may be necessary to call the distributor from whom you purchased it.

TROUBLESHOOTING

1. No dialing tone

- Check the telephone network
- Check the connection of handset cord and straight line cord

2. No ringing or no continuous ring

- Check the telephone line
- Check the quantity of parallel phone sets.

3. Noise during talk

- Check the telephone line
- Check the handset cord

WARRANTY

This product is warranted for a period of 12 months from the date of purchase against faulty materials or workmanship.

If during this period a defect arises, we may repair or replace the product, at Bittel's discretion, provided that:

1. The product has not been used for any purpose other than normal use.
2. Unauthorized product repair or modifications have not been attempted.
3. The product has never been used in a harsh or corrosive environment.
4. No damage in transit.

THIS LIMITED WARRANTY GIVES THE BUYER SPECIFIC LEGAL RIGHTS. THE BUYER MAY ALSO HAVE OTHER RIGHTS WHICH VARY FROM JURISDICTION TO JURISDICTION.

This warranty is only valid for merchandise purchased directly from Bittel or dealers or distributors authorized by Bittel Co.

FCC APPROVAL

Complies with Part 68 of the FCC rules. On the bottom of this telephone is a label that contains, among other information, the FCC registration number and the ringer equivalence number (REN) for this telephone. If requested, you must provide this information to the Telephone Company.

EC Declaration of Conformity



Hereby Bittel declares that this equipment (Telephone IP60D, type JJ IP60D incl. Cordless handset HS20D) is in compliance with the essential requirements and other relevant provisions of Directive 2014/53/EU.

Jacks:

Use RJ11C USOC standard modular jacks.

CONTACT INFORMATION

Shandong Bittel Intelligent Technology Co., Ltd.

Telephone: (86) 633-2212119/2212113

Internet: www.bittelgroup.com, www.hotellphone.com

Email: info@bittelgroup.com

Address: Shandong Bittel Intelligent Technology Co., Ltd.
No. 1 Rizhao North Road, Rizhao, Shandong,
276800, China

Service center North America:

Bittel Technology Inc.

1722 Little Orchard Street San Jose, California 95125 USA

Telephone: 1-888-9-BITTEL or 1-408-298-8206

Copyright © 2015 Bittel Inc. All rights reserved.

Produced in licence from:

Bell Xpress A/S

Telephone: (45) 70 22 60 33

Internet: www.bellxpress.dk

Email: mail@bellxpress.dk

Address: Sletvej 50, DK-8310 Tranbjerg J, Denmark

ENVIRONMENTAL CONCERNS AND DISPOSAL

Electric and electronic appliances contain materials, components and substances that can be damaging to people's health and to the environment, if the waste is not disposed of correctly. Electric and electronic appliances are marked with a crossed-out wheellie bin symbol as illustrated below. It indicates that electric and electronic appliances are banned from being disposed of as general household waste, and have to be collected separately.

Please ask you dealer about current means of disposal.



- The contents of this manual are subject to change without notice.
- The manufacturer and its suppliers accept no liability whatsoever for any damage, expense, loss of profits or any other damage incurred as a result of using this product.

Product by: Bell Xpress A/S, Sletvej 50, 8310 Tranbjerg J, Denmark · www.bellxpress.dk

www.jacobjensen.com



Generation to generation...